

$\overline{.006}$ ACROSS ALL SOLDER CHARGES

LEAD CODE
1 = TIN
2 = TIN/LEAD

DATE CODE

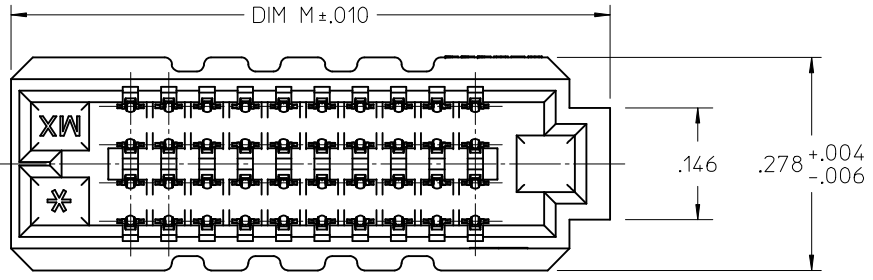

ROW 1 / CKT 1 ID

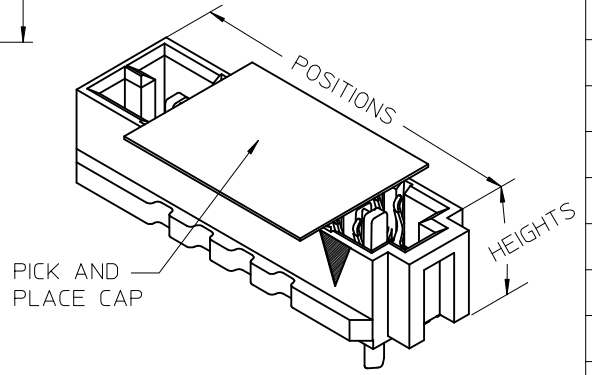
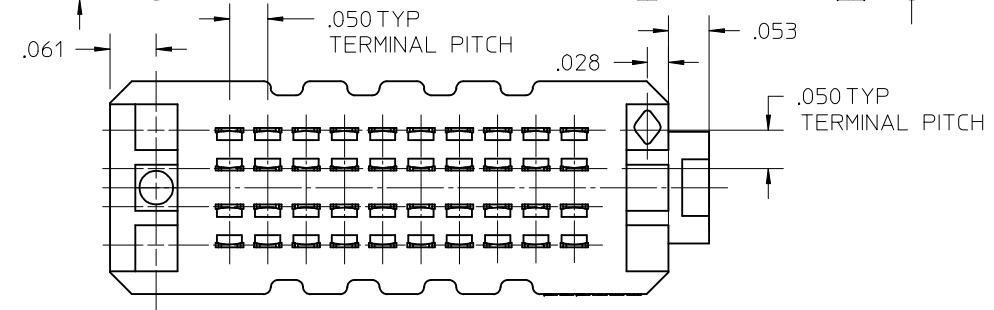
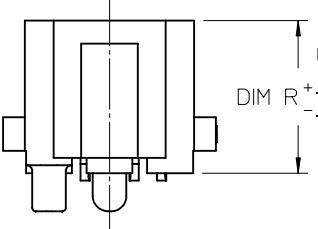
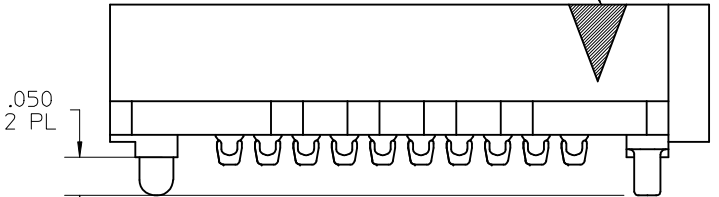

POSITION	DIM M	$\overline{.006}$
10	.782	.006
15	1.032	.006
20	1.282	.006
25	1.532	.006
30	1.782	.006
35	2.032	.006
40	2.282	.006
45	2.532	.009
50	2.782	.009

- NOTES:
- MATERIALS: HOUSING- LCP, UL94V-0, BLACK
CONTACTS- COPPER ALLOY
SOLDER CHARGE: SEE CHART
 - FINISH: SELECT GOLD IN CONTACT AREA: 30 MI MIN
SELECT TIN IN TAIL, 50 MI MIN
OVERALL NICKEL
 - PRODUCT SPECIFICATION: PS-45970-001
 - PACKAGING SPECIFICATION: PK-45971-002
 - MATES WITH SEARAY SLIM PLUG ASSY 46556
 - APPLICATION SPECIFICATION: AS-45970-001
 - COSMETIC SPECIFICATION: PS-45499-002 CLASS B
 - PART STATUS: CONTACT MOLEX

REV	DESCRIPTION	QUALITY SYMBOLS
M	UPDT. PKG SPEC IN NOTES EC NO: UCP2013-1396 DRWN: TIBARRA 2012/10/09 CHKD: BBARKER 2012/10/09 APPR: SMILLER 2012/10/16	$\nabla = 0$ $\nabla = 0$ $\nabla = 0$

GENERAL TOLERANCES (UNLESS SPECIFIED)	
	mm
4 PLACES	± .005
3 PLACES	± .005
2 PLACES	± .005
1 PLACE	± .005
0 PLACE	± .005
ANGULAR ± .005°	
DRAFT WHERE APPLICABLE MUST REMAIN WITHIN DIMENSIONS	

DIMENSION STYLE INCH ONLY	
DRAWN BY	DATE
TGREGOR I	2007/05/21
CHECKED BY	DATE
JCOMERC I	2007/05/21
APPROVED BY	DATE
JCOMERC I	2010/03/05
MATERIAL NO.	SEE TABLE
SIZE	A

SCALE	DESIGN UNITS	THIRD ANGLE PROJECTION	
4:1	INCH	\odot	\square
TITLE SEARAY SLIM RECEPTACLE ASSEMBLY .050 PITCH			
molex			
DOCUMENT NO.		SHEET NO.	
SD-46557-001		1 OF 4	

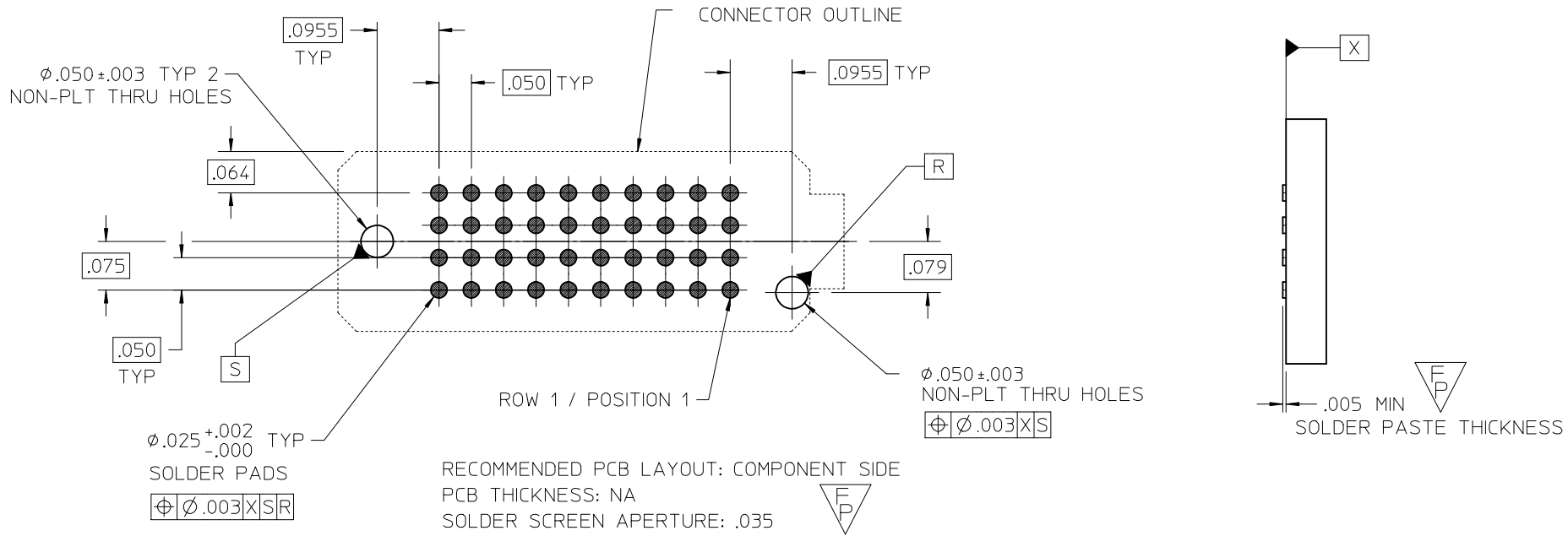

		DIM R RECEPTACLE STACK HEIGHT					
		MM	5.0	6.0	6.5	7.5	8.0
DIM P PLUG STACK HEIGHT	2.0	7.0	8.0	8.5	9.5	10.0	10.5
	3.0	8.0	9.0	9.5	10.5	11.0	11.5
	3.5	8.5	9.5	10.0	11.0	11.5	12.0
	2.5	7.5	8.5	9.0	10.0	10.5	11.0
	4.5	9.5	10.5	11.0	12.0	12.5	13.0
	5.0	10.0	11.0	11.5	12.5	13.0	13.5
	7.0	12.0	13.0	13.5	14.5	15.0	

STACK HEIGHTS GIVEN IN MM FOR REF ONLY

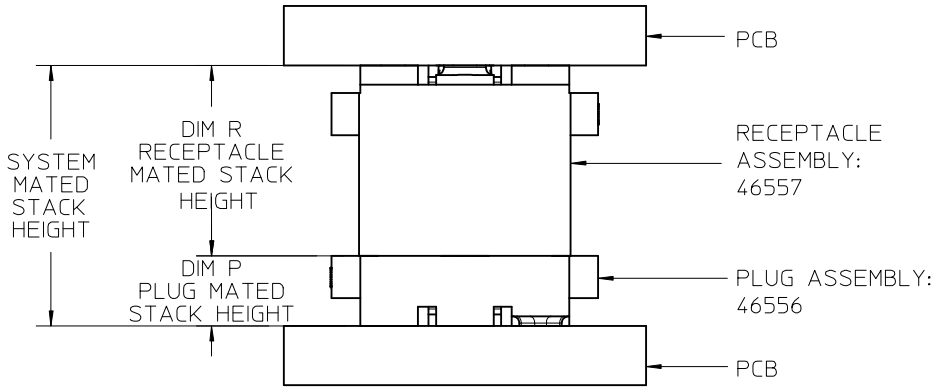

SEE SHEET 1 EC NO: UCP2013-1396 DRWN: TIBARRA 2012/10/09 CHKD: BBARKER 2012/10/09 APPR: SMILLER 2012/10/16	QUALITY SYMBOLS $\nabla = 0$ $\nabla = 0$ $\nabla = 2$	GENERAL TOLERANCES (UNLESS SPECIFIED)		DIMENSION STYLE INCH ONLY	SCALE 4:1	DESIGN UNITS INCH	THIRD ANGLE PROJECTION		
		4 PLACES	± ---	± ---	DRAWN BY TGREGORI	DATE 2007/05/21	TITLE SEARAY SLIM RECEPTACLE ASSEMBLY .050 PITCH molex DOCUMENT NO. SD-46557-001 SHEET NO. 2 OF 4		
		3 PLACES	± ---	± .005	CHECKED BY JCOMERCI	DATE 2007/05/21			
		2 PLACES	± ---	± ---	APPROVED BY JCOMERCI	DATE 2010/03/05			
1 PLACE	± ---	± ---	MATERIAL NO. SEE TABLE						
M	REV	ANGULAR ± ---°		DRAFT WHERE APPLICABLE MUST REMAIN WITHIN DIMENSIONS			THIS DRAWING CONTAINS INFORMATION THAT IS PROPRIETARY TO MOLEX INCORPORATED AND SHOULD NOT BE USED WITHOUT WRITTEN PERMISSION		

	6	5	4	3	2	1
DIM R: (REF)	5.0 MM	6.0 MM	6.5 MM	7.5 MM	8.0 MM	STACK HEIGHTS GIVEN IN MM FOR REF ONLY
DIM R: HOUSING HEIGHT	.199	.238	.258	.297	.317	
POSITIONS	MATERIAL NO	MATERIAL NO	MATERIAL NO	MATERIAL NO	MATERIAL NO	
10	46557-1145	46557-1245	46557-1345	46557-1445	46557-1545	
20	46557-2145	46557-2245	46557-2345	46557-2445	46557-2545	
30	46557-3145	46557-3245	46557-3345	46557-3445	46557-3545	
40	46557-4145	46557-4245	46557-4345	46557-4445	46557-4545	
50	46557-5145	46557-5245	46557-5345	46557-5445	46557-5545	
15	46557-6145	46557-6245	46557-6345	46557-6445	46557-6545	
25	46557-7145	46557-7245	46557-7345	46557-7445	46557-7545	
35	46557-8145	46557-8245	46557-8345	46557-8445	46557-8545	
45	46557-9145	46557-9245	46557-9345	46557-9445	46557-9545	

NOTES:

- THIS SHEET CONTAINS THE FOLLOWING OPTIONS
SOLDER CHARGE: TIN, 95.5/ Ag 3.8/ Cu 0.7

SEE SHEET 1 EC NO: UCP2013-1396 DRWN: TIBARRA 2012/10/09 CHKD: BBARKER 2012/10/09 APPR: MILLER 2012/10/16	DESCRIPTION REV	QUALITY SYMBOLS	GENERAL TOLERANCES (UNLESS SPECIFIED)		DIMENSION STYLE INCH ONLY		SCALE 1:1	DESIGN UNITS INCH	THIRD ANGLE PROJECTION			
		$\nabla = 0$ $\nabla = 0$ $\nabla = 0$		mm	INCH	DRAWN BY	DATE	TITLE SEARAY SLIM RECEPTACLE ASSEMBLY .050 PITCH				
			4 PLACES	± ---	± ---	TGREGOR I	2007/05/21					
			3 PLACES	± ---	± .005	CHECKED BY	DATE					
			2 PLACES	± ---	± ---	JCOMERC I	2007/05/21					
1 PLACE	± ---		± ---	APPROVED BY	DATE							
0 PLACE	±	±	JCOMERC I	2010/03/05	MATERIAL NO.		DOCUMENT NO.		SHEET NO.			
DRAFT WHERE APPLICABLE MUST REMAIN WITHIN DIMENSIONS			SEE TABLE		SD-46557-001		3 OF 4					
THIS DRAWING CONTAINS INFORMATION THAT IS PROPRIETARY TO MOLEX INCORPORATED AND SHOULD NOT BE USED WITHOUT WRITTEN PERMISSION												

	6	5	4	3	2	1
DIM R: (REF)	5.0 MM	6.0 MM	6.5 MM	7.5 MM	8.0 MM	STACK HEIGHTS GIVEN IN MM FOR REF ONLY
DIM R: HOUSING HEIGHT	.199	.238	.258	.297	.317	
POSITIONS	MATERIAL NO	MATERIAL NO	MATERIAL NO	MATERIAL NO	MATERIAL NO	
10	46557-1147	46557-1247	46557-1347	46557-1447	46557-1547	
20	46557-2147	46557-2247	46557-2347	46557-2447	46557-2547	
30	46557-3147	46557-3247	46557-3347	46557-3447	46557-3547	
40	46557-4147	46557-4247	46557-4347	46557-4447	46557-4547	
50	46557-5147	46557-5247	46557-5347	46557-5447	46557-5547	
15	46557-6147	46557-6247	46557-6347	46557-6447	46557-6547	
25	46557-7147	46557-7247	46557-7347	46557-7447	46557-7547	
35	46557-8147	46557-8247	46557-8347	46557-8447	46557-8547	
45	46557-9147	46557-9247	46557-9347	46557-9447	46557-9547	

NOTES:

- THIS SHEET CONTAINS THE FOLLOWING OPTIONS
SOLDER CHARGE: TIN / LEAD, 63/Pb 37

SEE SHEET 1 EC NO: UCP2013-1396 DRWN: TIBARRA 2012/10/09 CHKD: BBARKER 2012/10/09 APPR: SMILLER 2012/10/16	REV DESCRIPTION	QUALITY SYMBOLS	GENERAL TOLERANCES (UNLESS SPECIFIED)		DIMENSION STYLE INCH ONLY		SCALE 1:1	DESIGN UNITS INCH	THIRD ANGLE PROJECTION			
		$\nabla = 0$ $\nabla = 0$ $\nabla = 0$		mm	INCH	DRAWN BY	DATE	TITLE SEARAY SLIM RECEPTACLE ASSEMBLY .050 PITCH				
			4 PLACES	± ---	± ---	TGREGORI	2007/05/21					
			3 PLACES	± ---	± .005	CHECKED BY	DATE					
			2 PLACES	± ---	± ---	JCOMERC I	2007/05/21					
1 PLACE	± ---		± ---	APPROVED BY	DATE							
0 PLACE	±	±	JCOMERC I	2010/03/05	MATERIAL NO.		DOCUMENT NO.			SHEET NO.		
ANGULAR ± ---°			DRAFT WHERE APPLICABLE MUST REMAIN WITHIN DIMENSIONS		SEE TABLE		SD-46557-001			4 OF 4		
SIZE A		THIS DRAWING CONTAINS INFORMATION THAT IS PROPRIETARY TO MOLEX INCORPORATED AND SHOULD NOT BE USED WITHOUT WRITTEN PERMISSION										